



SORAA VIVID™

Soraa VIVID lamps offer beautiful and accurate color and white rendering across the entire visible spectrum, mimicking the natural range of sunlight to deliver unmatched quality of light for color critical applications.

POINT SOURCE OPTICS™

Point Source Optics deliver exceptional beam quality with crisp shadows, perfect uniformity and precisely controlled beam distributions from 10° to 60°.

SORAA VIVID COLOR™

Soraa VIVID lamps utilize full spectrum light to provide industry-leading color rendition of CRI/95, R9/95, Rf/90, Rg/100 for precise color reproduction.

SORAA NATURAL WHITE™

Soraa VIVID lamps are engineered to deliver outstanding whiteness rendering for true-to-life whites, which matches or exceeds incandescent sources at 2700K and 3000K.

ENERGY EFFICIENCY

85% more energy efficient than standard halogen lamps, with typical payback of one year or less.

GENERAL SPECIFICATIONS

Form Factor

Width: 49.9mm (1.96")

Height: 53.5mm (2.10")

Weight: 61g

Operating Temperature

Minimum: -40°C (ambient)

Typical: 85°C - 95°C (base)

Maximum: 100°C (base)

Electrical

Wattage: 7.5W

Power factor: 0.93

Voltage: 120V +/- 12V

Frequency: 50/60Hz

Dimming

Please reference our compatibility chart for dimmer and transformer information.

Output	390 - 455 lumen
Beam Angle	10°, 25°, 36°, 60°
Color Temperature	2700K, 3000K, 4000K
Color Metrics	CIE Metrics: CRI 95, R9 95 TM30 Metrics: Rf 90, Rg 100 Whiteness Index: Rw 100
Applications	Hotels & Hospitality Galleries & Museums High-End Retail



ACCESSORIES

Narrow spot compatible with the Soraa SNAP System™.

THERMAL COMPATIBILITY

Suitable for use in fully enclosed fixtures, subject to the maximum heatsink temperature limits stated in this data sheet. Designed to safely turn down in high temperature environments to protect LED and components.

ELECTRICAL COMPATIBILITY

Works with trailing edge and leading edge phase cut dimmers. Check individual lamp website pages for compatibility data. For more information visit: www.soraa.com.

INTENDED USE & LOCATION RATING

Intended for use in MR16 GU10 compatible recessed downlights, track lighting and other indoor applications. Suitable for damp locations; not rated for use in wet locations.

LIFETIME & WARRANTY

Rated lifetime to L70: 35,000hrs

Warranty: 3yrs or 25,000hrs whichever comes first

For warranty information visit: www.soraa.com/resources/legal



RoHS



DIMENSIONS

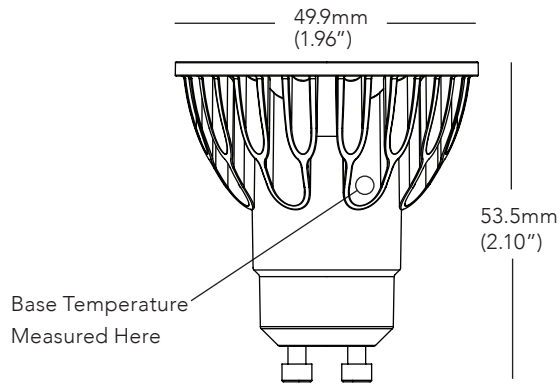

COLOR RENDERING

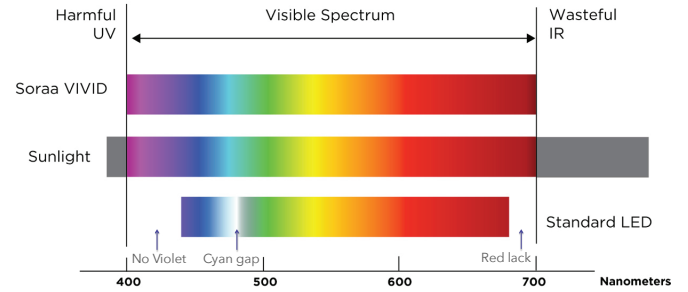

10 DEGREE BEAM

Beam Dia at 50% CBCP (ft)	Field Dia at 10% CBCP (ft)	Foot-candles (% of CBCP)
0.5	1.1	11.1%
1.0	2.1	2.8%
1.6	3.2	1.2%
2.1	4.2	0.7%
2.6	5.3	0.4%

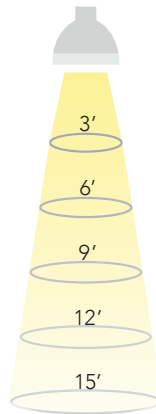

25 DEGREE BEAM

Beam Dia at 50% CBCP (ft)	Field Dia at 10% CBCP (ft)	Foot-candles (% of CBCP)
1.3	2.1	11.1%
2.7	4.1	2.8%
4.0	6.2	1.2%
5.3	8.3	0.7%
6.7	10.3	0.4%

36 DEGREE BEAM

Beam Dia at 50% CBCP (ft)	Field Dia at 10% CBCP (ft)	Foot-candles (% of CBCP)
1.9	3.1	11.1%
3.9	6.1	2.8%
5.8	9.2	1.2%
7.8	12.2	0.7%
9.7	15.3	0.4%

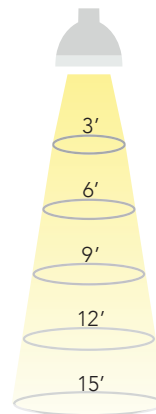

60 DEGREE BEAM

Beam Dia at 50% CBCP (ft)	Field Dia at 10% CBCP (ft)	Foot-candles (% of CBCP)
3.5	5.4	11.1%
6.9	10.8	2.8%
10.4	16.2	1.2%
13.9	21.6	0.7%
17.3	27.0	0.4%

Note: Footcandles may be calculated by multiplying the CBCP of the desired model number by the percentage in the tables above

SPECIFICATIONS BY MODEL NUMBER* SORAA LED MR16-GU10 7.5W 120V

Model #	Product Code	CCT (K)	Beam Angle	Field Angle	CBCP (Cd)	Total Flux (Lm)	Efficacy (Lm/W)	McA	SNAP
VIVID SERIES									
SM16GA-07-10D-927-03	01111	2700	10	17	5710	390	52	3	YES
SM16GA-07-25D-927-03	01123	2700	25	38	2260	410	55	3	-
SM16GA-07-36D-927-03	01135	2700	36	54	1070	410	55	3	-
SM16GA-07-60D-927-03	01573	2700	60	84	420	410	55	3	-
SM16GA-07-10D-930-03	01115	3000	10	17	6000	410	55	3	YES
SM16GA-07-25D-930-03	01127	3000	25	38	2400	435	58	3	-
SM16GA-07-36D-930-03	01139	3000	36	54	1130	435	58	3	-
SM16GA-07-60D-930-03	01577	3000	60	84	440	435	58	3	-
SM16GA-07-10D-940-03	01117	4000	10	17	6290	430	58	4	YES
SM16GA-07-25D-940-03	01129	4000	25	38	2510	455	61	4	-
SM16GA-07-36D-940-03	01141	4000	36	54	1190	455	61	4	-
SM16GA-07-60D-940-03	01579	4000	60	84	460	455	61	4	-

CCT: Correlated Color Temperature **McA:** White Point Accuracy in McA step **SNAP:** SORAA SNAP System Compatible

*Specifications are at stable warm operating conditions (25°C ambient)

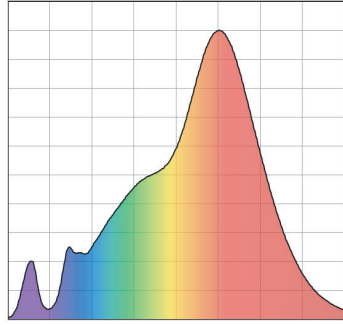
CCT**SPECTRAL POWER DISTRIBUTION****COLOR QUALITY METRICS****COLOR ACCURACY****VIVID
2700K****CRI: 95, R9: 95**

CRI	95
R9	95
Rf	95
Rg	100
Rf-h1	95
Rw	90

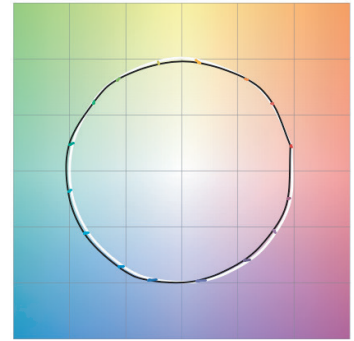
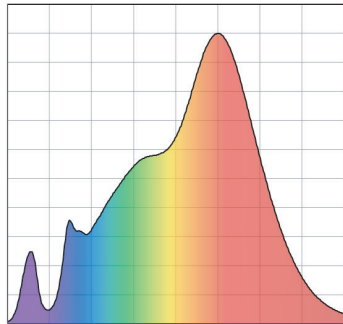
**VIVID
3000K****CRI: 95, R9: 95**

CRI	95
R9	95
Rf	95
Rg	100
Rf-h1	95
Rw	90

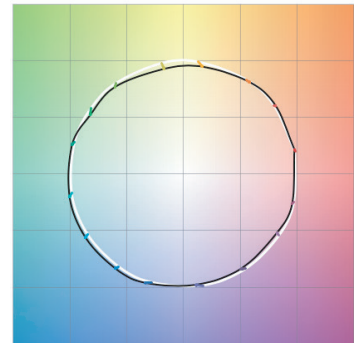
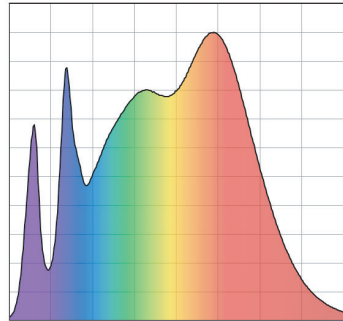
**VIVID
4000K****CRI: 95, R9: 95**

CRI	95
R9	95
Rf	98
Rg	100
Rf-h1	100
Rw	100

