



SORAA VIVID™

Soraa VIVID lamps offer beautiful and accurate color and white rendering across the entire visible spectrum, mimicking the natural range of sunlight to deliver unmatched quality of light for color critical applications.

POINT SOURCE OPTICS™

Point Source Optics deliver exceptional beam quality with crisp shadows, perfect uniformity and precisely controlled beam distributions from 10° to 60°.

SORAA VIVID COLOR™

Soraa VIVID lamps utilize full spectrum light to provide industry-leading color rendition of CRI/95, R9/95, Rf/90, Rg/100 for precise color reproduction.

SORAA NATURAL WHITE™

Soraa VIVID lamps are engineered to deliver outstanding whiteness rendering for true-to-life whites, which matches or exceeds incandescent sources at 2700K and 3000K.

ACCESSORIES

Narrow spot compatible with the Soraa SNAP SYSTEM

GENERAL SPECIFICATIONS

Form Factor

Width: 64mm (2.52")

Height: 77mm (3.04")

Weight: 160g

Operating Temperature

Minimum: -40°C (ambient)

Typical: 70°C - 80°C (base)

Maximum: 90°C (base)

Electrical

Wattage (Nominal): 10.8W

Power factor: 0.92

Voltage: 100V +/- 10V

Frequency: 50/60Hz

Dimming

Please reference our compatibility chart for dimmer and transformer information.

Output	500 - 540 lumen
Beam Angle	10°, 25°, 36°, 60°
Color Temperature	2700K, 3000K
Color Metrics	CIE Metrics: CRI 95, R9 95 TM30 Metrics: Rf 90, Rg 100 Whiteness Index: Rw 100
Applications	Hotels & Hospitality Galleries & Museums High-End Retail



ENERGY EFFICIENCY

85% more energy efficient than standard halogen lamps, with typical payback of one year or less.

THERMAL COMPATIBILITY

Suitable for use with standard fixtures, subject to the maximum heatsink temperature limits stated in this data sheet. Designed to safely turn down in high temperature environments to protect LED and components.

ELECTRICAL COMPATIBILITY

Works with trailing edge and leading edge phase cut dimmers. Check individual lamp website pages for compatibility data. For more information visit: www.soraa.com.

INTENDED USE & LOCATION RATING

Intended for use in PAR20 compatible recessed downlights, track lighting and other indoor and outdoor applications. Suitable for damp locations, not rated for use in wet locations.

LIFETIME & WARRANTY

Rated lifetime to L70: 35,000hrs

Warranty: 3yrs or 25,000hrs whichever comes first

For warranty information visit: www.soraa.com/resources/legal



RoHS



DIMENSIONS

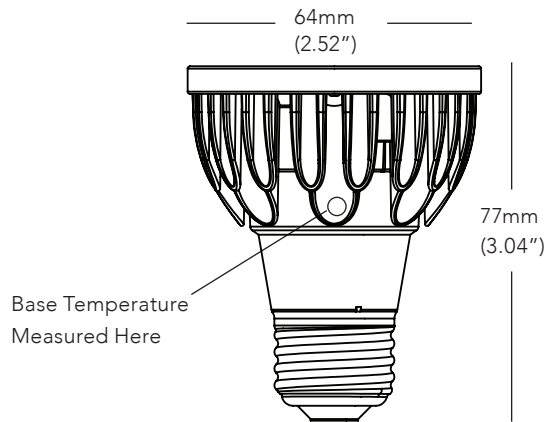

COLOR RENDERING

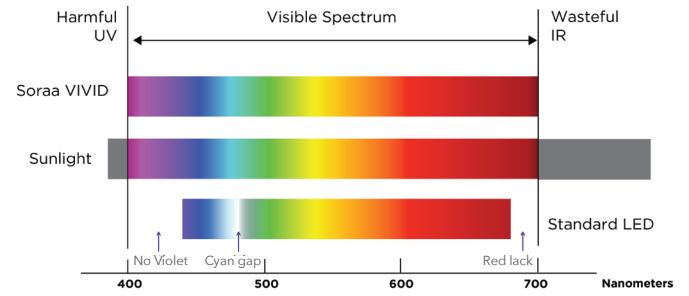

10 DEGREE BEAM

Beam Dia at 50% CBCP (ft)	Field Dia at 10% CBCP (ft)	Foot-candles (% of CBCP)
0.5	1.1	11.1%
1.0	2.1	2.8%
1.6	3.2	1.2%
2.1	4.2	0.7%
2.6	5.3	0.4%

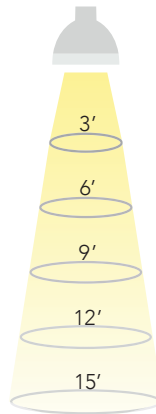

25 DEGREE BEAM

Beam Dia at 50% CBCP (ft)	Field Dia at 10% CBCP (ft)	Foot-candles (% of CBCP)
1.3	2.2	11.1%
2.7	4.4	2.8%
4.0	6.6	1.2%
5.3	8.7	0.7%
6.7	10.9	0.4%

36 DEGREE BEAM

Beam Dia at 50% CBCP (ft)	Field Dia at 10% CBCP (ft)	Foot-candles (% of CBCP)
1.9	3.5	11.1%
3.9	6.9	2.8%
5.8	10.4	1.2%
7.8	13.9	0.7%
9.7	17.3	0.4%

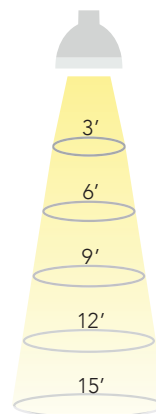

60 DEGREE BEAM

Beam Dia at 50% CBCP (ft)	Field Dia at 10% CBCP (ft)	Foot-candles (% of CBCP)
3.5	6.0	11.1%
6.9	12.0	2.8%
10.4	18.0	1.2%
13.9	24.0	0.7%
17.3	30.0	0.4%

Note: Footcandles may be calculated by multiplying the CBCP of the desired model number by the percentage in the tables above

SPECIFICATIONS BY MODEL NUMBER* SORAA LED PAR20 11W 100V

Model #	Product Code	CCT (K)	Beam Angle	Field Angle	CBCP (Cd)	Total Flux (Lm)	Efficacy (Lm/W)	McA	SNAP
VIVID SERIES									
SP20-11-10D-927-03-S5	02871	2700K	10	20	8000	500	47	3	YES
SP20-11-25D-927-03-S5	02873	2700K	25	40	2640	500	47	3	-
SP20-11-36D-927-03-S5	02875	2700K	36	60	1240	500	47	3	-
SP20-11-60D-927-03-S5	02877	2700K	60	90	540	500	47	3	-
SP20-11-10D-930-03-S5	02887	3000K	10	20	8640	540	50	3	YES
SP20-11-25D-930-03-S5	02889	3000K	25	40	2860	540	50	3	-
SP20-11-36D-930-03-S5	02891	3000K	36	60	1340	540	50	3	-
SP20-11-60D-930-03-S5	02893	3000K	60	90	580	540	50	3	-
SP20-11-10D-940-03-S5	02903	4000K	10	20	8960	560	52	3	YES
SP20-11-25D-940-03-S5	02905	4000K	25	40	2960	560	52	3	-

CCT: Correlated Color Temperature **McA:** White Point Accuracy in McA step **SNAP:** SORAA SNAP System Compatible

*Specifications are at stable warm operating conditions (25°C ambient)

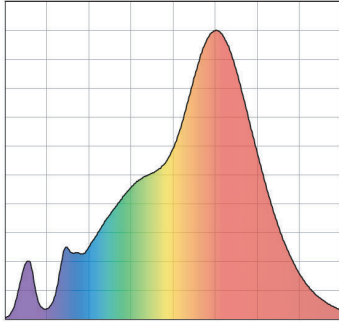
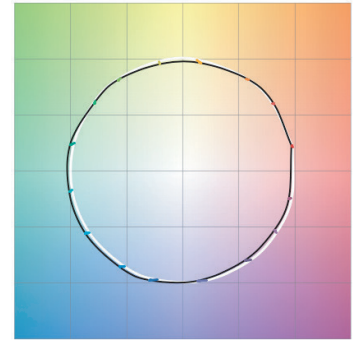
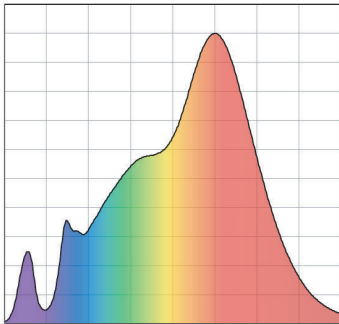
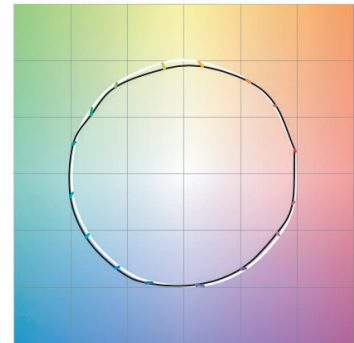
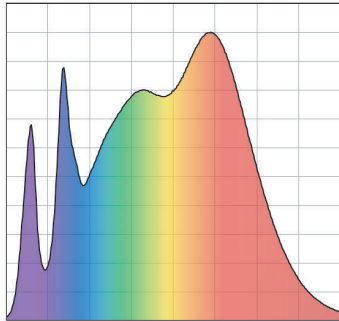
CCT**SPECTRAL POWER DISTRIBUTION****COLOR QUALITY METRICS****COLOR ACCURACY****VIVID
2700K****CRI: 95, R9: 95****CRI** 95**R9** 95**Rf** 95**Rg** 100**Rf-h1** 95**Rw** 90**VIVID
3000K****CRI: 95, R9: 95****CRI** 95**R9** 95**Rf** 95**Rg** 100**Rf-h1** 95**Rw** 90**VIVID
4000K****CRI: 95, R9: 95****CRI** 95**R9** 95**Rf** 98**Rg** 100**Rf-h1** 100**Rw** 100