



HIGH COLOR QUALITY, ENCLOSED FIXTURE COMPATIBLE LED LAMP FOR USE IN A19 COMPATIBLE FIXTURES AND OTHER INDOOR AND OUTDOOR APPLICATIONS

OUTPUT RANGE 800 lumen

BEAM ANGLE Omnidirectional

VOLTAGE 100V +/- 10V

COLOR METRICS
 CCT: 2700K
 Color Rendering
 CIE Metrics: CRI 95, R9 95
 TM30 Metrics: Rf 90, Rfh1 90
 Whiteness Index: Rw 100

APPLICATION Incandescent replacement for indoor and outdoor applications



OUR LIGHT IS PERFECT BECAUSE WE INVENTED IT TO BE

We design the smallest sources and pair them with our unique full spectrum technology, for perfect color and light distribution in a range of lamp form factors.

SORAA VIVID COLOR™

Soraa lamps provide beautiful and accurate color rendering across the entire visible spectrum, with CRI/95, R9/95, Rf/90, Rg/100

SORAA NATURAL WHITE™

Soraa lamps clearly differentiate infinite shades of white; whiteness rendering matches or exceeds halogen and incandescent sources at 2700K and 3000K.

FLICKER

Soraa lamps demonstrate low levels of flicker, achieving <30% flicker in both dimmed and undimmed states.

THERMALLY COMPATIBLE

Suitable for use in fully enclosed fixtures, subject to the maximum heatsink temperature limits stated in this data sheet. A list of qualified enclosed fixtures can be found at www.soraa.com/resources. Soraa lamps are designed to safely turn down in any thermal environment not conducive to minimum airflow or proper ventilation.

ELECTRICALLY COMPATIBLE

Works with trailing edge and leading edge phase cut dimmers. A list of compatible dimmers and transformers can be found at www.soraa.com/resources/compatibility.

LOCATION RATING

Suitable for damp locations
 Not rated for use in wet locations, should not be exposed to liquid water (including condensation).

FORM FACTOR

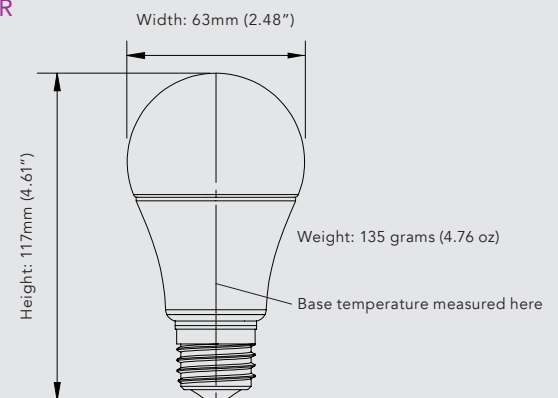

COLOR RENDERING

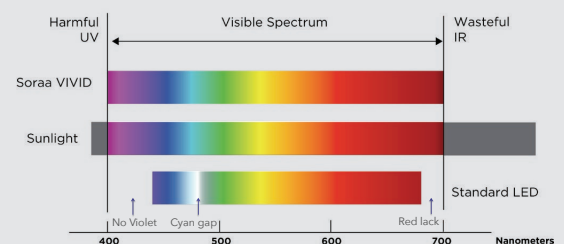

LIFETIME AND WARRANTY

Rated lifetime to L70: 25,000 hours
 Warranty: 3 years or 25,000 hours whichever comes first
 Detailed warranty information available at: soraa.com/resources/legal

OPERATING TEMPERATURE

Minimum: -40° C (ambient)
 Typical: 80° C - 95° C (lamp base)
 Maximum: 100° C (lamp base)

ELECTRICAL SPECIFICATIONS

Wattage: 11W
 Voltage: 100V +/- 10V
 Frequency: 50/60 Hz
 Power Factor: 0.95
 Dimmability: <20%
 Flicker Index: <0.08
 Percent Flicker: <30%

CERTIFICATIONS

PSE, RoHS



RoHS

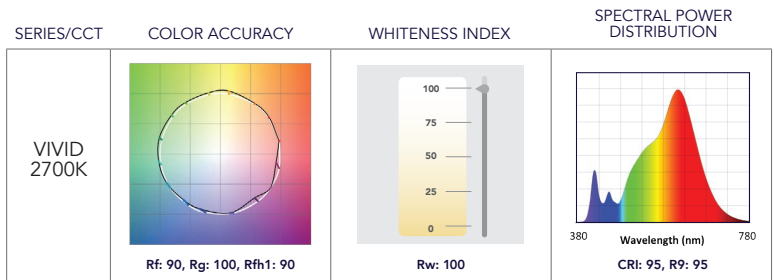

POLAR DIAGRAM

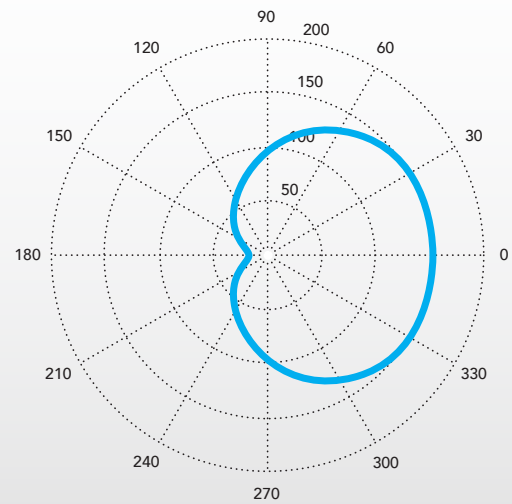

Model Number	Product Code	CCT (K)	Total Flux (Lm)	Beam Angle (°)	Halogen Equiv (W)**	Efficacy (Lm/W)	CRI/R9	Rf	White Point (McA)
VIVID SERIES									
SA19-11-OMNI-927-01-S5	07371	2700	800	OMNI	60	73	95 / 95	90	3

*Specifications are at stable warm operating conditions (25°C ambient) **Energy Star Minimum

CCT = Correlated Color Temperature CRI = Color Rendering Index (Ra-8) White Point = White Point Accuracy in McA step