



SORAA VIVID™

Soraa VIVID lamps offer beautiful and accurate color and white rendering across the entire visible spectrum, mimicking the natural range of sunlight to deliver unmatched quality of light for color critical applications.

POINT SOURCE OPTICS™

Point Source Optics deliver exceptional beam quality with crisp shadows, perfect uniformity and precisely controlled beam distributions from 9° to 60°.

SORAA VIVID COLOR™

Soraa VIVID lamps utilize full spectrum light to provide industry-leading color rendition of CRI/95, R9/95, Rf/90, Rg/100 for precise color reproduction.

SORAA NATURAL WHITE™

Soraa VIVID lamps are engineered to deliver outstanding whiteness rendering for true-to-life whites, which matches or exceeds incandescent sources at 2700K and 3000K.

ACCESSORIES

Narrow spot compatible with the Soraa SNAP SYSTEM

™

GENERAL SPECIFICATIONS

Form Factor

Width: 122mm (4.80")

Height: 125mm (4.92")

Weight: 305g

Operating Temperature

Minimum: -40°C (ambient)

Typical: 70°C - 80°C (base)

Maximum: 90°C (base)

Electrical

Wattage: 18.5W

Power factor: 0.95

Voltage: 120V +/- 12V

Frequency: 50/60Hz

Dimming

Please reference our compatibility chart for dimmer and transformer information.

Output	930 - 1000 lumen
Beam Angle	9°, 25°, 36°, 60°
Color Temperature	2700K, 3000K
Color Metrics	CIE Metrics: CRI 95, R9 95 TM30 Metrics: Rf 90, Rg 100 Whiteness Index: Rw 100
Applications	Hotels & Hospitality Galleries & Museums High-End Retail



ENERGY EFFICIENCY

85% more energy efficient than standard halogen lamps, with typical payback of one year or less.

THERMAL COMPATIBILITY

Suitable for use with standard fixtures, subject to the maximum heatsink temperature limits stated in this data sheet. Designed to safely turn down in high temperature environments to protect LED and components.

ELECTRICAL COMPATIBILITY

Works with trailing edge and leading edge phase cut dimmers. Check individual lamp website pages for compatibility data. For more information visit: www.soraa.com.

INTENDED USE & LOCATION RATING

Intended for use in PAR38 compatible recessed downlights, track lighting and other indoor and outdoor applications. Suitable for damp locations, not rated for use in wet locations.

LIFETIME & WARRANTY

Rated lifetime to L70: 35,000hrs

Warranty: 3yrs or 25,000hrs whichever comes first

For warranty information visit: www.soraa.com/resources/legal



DIMENSIONS

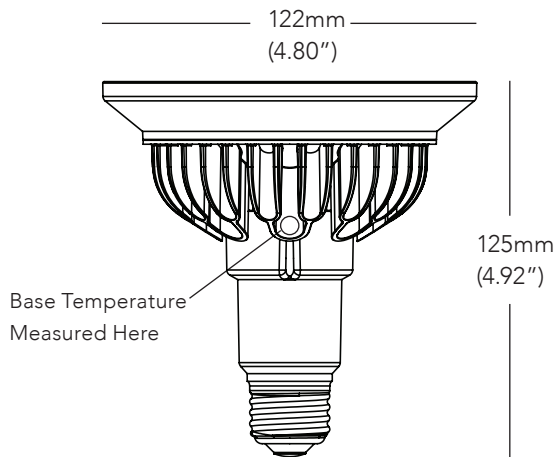

COLOR RENDERING

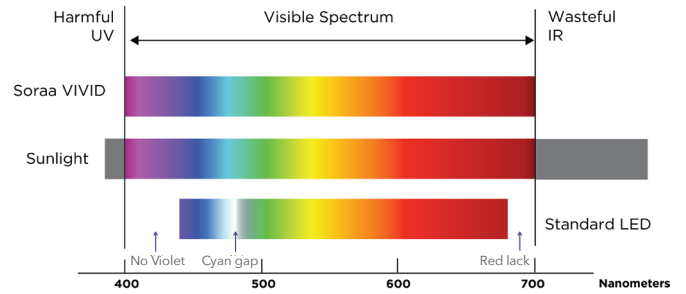

9 DEGREE BEAM

Beam Dia at 50% CBCP (ft)	Field Dia at 10% CBCP (ft)	Foot-candles (% of CBCP)
0.5	0.8	8.6%
0.9	1.7	2.5%
1.4	2.5	1.2%
1.9	3.4	0.7%
2.4	4.2	0.4%

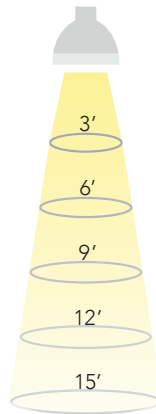

25 DEGREE BEAM

Beam Dia at 50% CBCP (ft)	Field Dia at 10% CBCP (ft)	Foot-candles (% of CBCP)
1.3	2.2	8.6%
2.7	4.4	2.5%
4.0	6.6	1.2%
5.3	8.7	0.7%
6.7	10.9	0.4%

60 DEGREE BEAM

36 DEGREE BEAM

Beam Dia at 50% CBCP (ft)	Field Dia at 10% CBCP (ft)	Foot-candles (% of CBCP)
1.9	3.5	8.6%
3.9	6.9	2.5%
5.8	10.4	1.2%
7.8	13.9	0.7%
9.7	17.3	0.4%

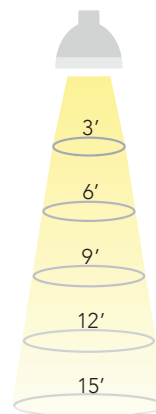

Beam Dia at 50% CBCP (ft)	Field Dia at 10% CBCP (ft)	Foot-candles (% of CBCP)
3.5	6.0	8.6%
6.9	12.0	2.5%
10.4	18.0	1.2%
13.9	24.0	0.7%
17.3	30.0	0.4%

Note: Footcandles may be calculated by multiplying the CBCP of the desired model number by the percentage in the tables above

SPECIFICATIONS BY MODEL NUMBER* SORAA LED PAR38 18.5W 120V

Model #	Product Code	CCT (K)	Beam Angle	Field Angle	CBCP (Cd)	Total Flux (Lm)	Efficacy (Lm/W)	McA	SNAP
VIVID SERIES									
SP38-18-09D-927-03	00977	2700	9	16	17200	930	50	3	YES
SP38-18-25D-927-03	00979	2700	25	40	5020	930	50	3	-
SP38-18-36D-927-03	00981	2700	36	60	2320	930	50	3	-
SP38-18-60D-927-03	00983	2700	60	90	1020	930	50	3	-
SP38-18-09D-930-03	00993	3000	9	16	18500	1000	54	3	YES
SP38-18-25D-930-03	00995	3000	25	40	5400	1000	54	3	-
SP38-18-36D-930-03	00997	3000	36	60	2500	1000	54	3	-
SP38-18-60D-930-03	00999	3000	60	90	1100	1000	54	3	-

CCT: Correlated Color Temperature **McA:** White Point Accuracy in McA step **SNAP:** SORAA SNAP System Compatible

*Specifications are at stable warm operating conditions (25°C ambient)

CCT

SPECTRAL POWER DISTRIBUTION

COLOR QUALITY METRICS

COLOR ACCURACY

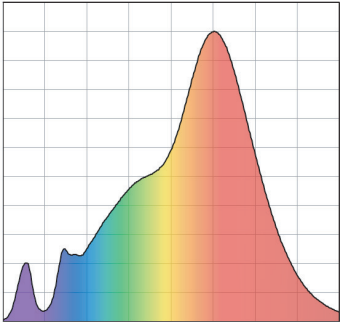
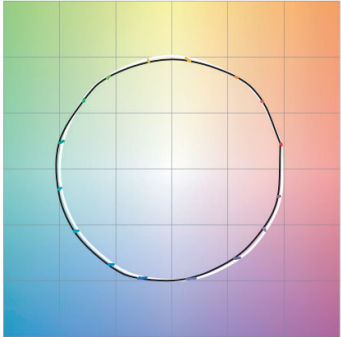
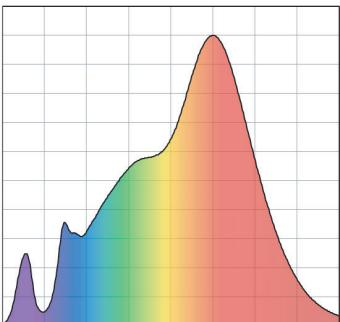
<p>VIVID 2700K</p>	 <p>CRI: 95, R9: 95</p>	<p>CRI 95</p> <p>R9 95</p> <p>Rf 95</p> <p>Rg 100</p> <p>Rf-h1 95</p> <p>Rw 90</p>	
<p>VIVID 3000K</p>	 <p>CRI: 95, R9: 95</p>	<p>CRI 95</p> <p>R9 95</p> <p>Rf 95</p> <p>Rg 100</p> <p>Rf-h1 95</p> <p>Rw 90</p>	